

6.5

Practice

For use after Lesson 6.5

Find the distance d . Round your answer to the nearest tenth.

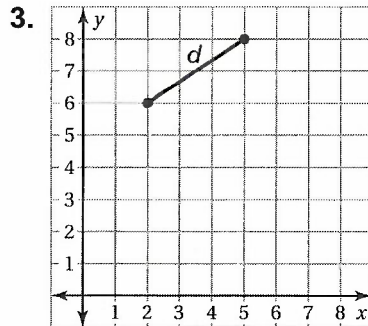
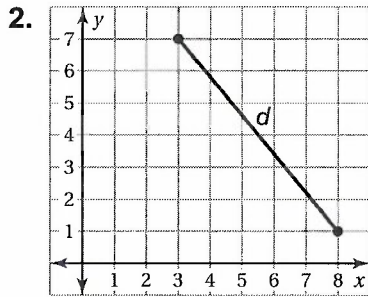
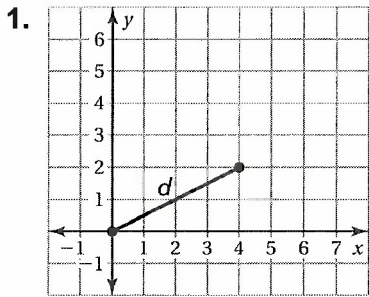

Find the height x . Round your answer to the nearest tenth.

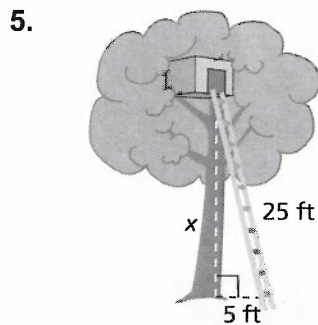
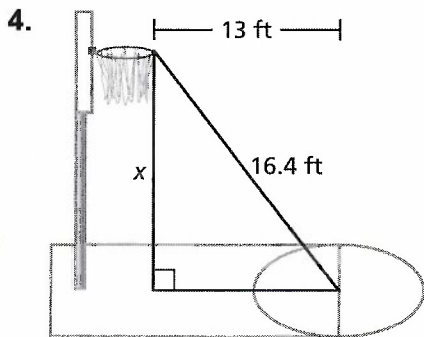

Tell whether the triangle with the given side lengths is a right triangle.

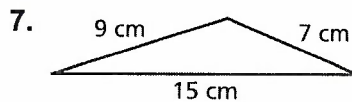
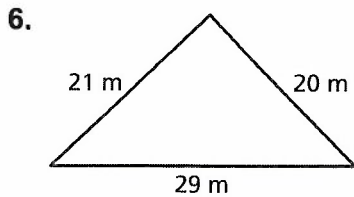

8. You set up a badminton net in your backyard. About how long is the rope used to secure the net?

